

# Operating Manual



## RCM420

Residual current monitor  
for AC current monitoring in TN and TT systems  
Software version: D240 V1.2x



**Bender GmbH & Co. KG**

Londorfer Str. 65 • 35305 Grünberg • Germany

Postfach 1161 • 35301 Grünberg • Germany

Tel.: +49 6401 807-0

Fax: +49 6401 807-259

E-Mail: [info@bender-de.com](mailto:info@bender-de.com)

Web: <http://www.bender-de.com>

© Bender GmbH & Co. KG

All rights reserved.

Reprinting only with permission  
of the publisher.

Subject to change!

---

# Table of Contents

<b>1. Effective use of this manual</b> .....	<b>5</b>
1.1 Notes for the user .....	5
1.2 Intended use .....	5
1.3 Information about factory setting .....	6
<b>2. Safety information</b> .....	<b>7</b>
2.1 Safety instructions .....	7
2.2 Work activities on electrical installations .....	7
<b>3. Function</b> .....	<b>9</b>
3.1 Device features .....	9
3.2 Function .....	9
3.2.1 Connection monitoring .....	10
3.2.2 Additional cascaded measuring current transformer .....	10
3.2.3 Fast response value query .....	10
3.2.4 Automatic self test .....	10
3.2.5 Manual self test .....	10
3.2.6 Functional faults .....	11
3.2.7 Set the number of reload cycles .....	11
3.2.8 Assigning alarm categories to alarm relays K1/K2 .....	11
3.2.9 Time delays $t$ , $t_{on}$ and $t_{off}$ .....	11
3.2.10 Starting delay $t$ .....	11
3.2.11 Response delay $t_{on1/2}$ .....	11
3.2.12 Delay on release $t_{off}$ .....	12
3.2.13 Residual current monitoring in window discriminator mode .....	12
3.2.14 Password protection (on, OFF) .....	12
3.2.15 Factory setting FAC .....	12
3.2.16 Erasable history memory .....	12
3.2.17 External, combined test respectively reset button T/R .....	12

3.2.18	Fault memory .....	12
<b>4.</b>	<b>Installation and connection .....</b>	<b>13</b>
<b>5.</b>	<b>Operation and setting .....</b>	<b>17</b>
5.1	Display elements .....	17
5.2	Function of the operating elements .....	18
5.3	Menu structure .....	19
5.4	Display in standard mode .....	21
5.5	Display in menu mode .....	22
5.5.1	Parameter query and setting: Overview .....	22
5.5.2	Changeover from overcurrent to undercurrent mode or to window mode .....	24
5.5.3	Response value setting for overcurrent: .....	25
5.5.4	Setting the fault memory and alarm relay operating mode .....	26
5.5.5	Assigning alarm categories to the alarm relays .....	27
5.5.6	Set the time delays .....	29
5.5.7	Changing from overcurrent operation to window operation .....	30
5.5.8	Setting the correction factor for an additional cascaded current transformer .....	30
5.5.9	Factory setting and password protection .....	31
5.5.10	Re-establishing the factory settings .....	32
5.5.11	Device information query .....	33
5.5.12	History memory query .....	33
5.6	Commissioning .....	34
5.7	Factory setting .....	34
5.8	Standards, approvals and certifications .....	34
<b>6.</b>	<b>Technical data .....</b>	<b>35</b>
6.1	Data in tabular form .....	35
6.2	Ordering information .....	38
6.3	Error codes .....	40
<b>INDEX</b>	<b>.....</b>	<b>41</b>

# 1. Effective use of this manual

## 1.1 Notes for the user

This manual is intended for experts in electrical engineering and electronics!

In order to make it easier for you to find specific text passages or references in this manual and for reasons of comprehensibility, important information is emphasized by symbols. The meaning of these symbols is explained below:



---

*Information calling attention to hazards are marked with this warning symbol.*

---



---

*Information intended to assist the user to make optimum use of the product are marked with the Info symbol.*

---

## 1.2 Intended use

The AC and pulsed DC sensitive residual current monitor RCM420 (Type A) from Bender is designed for fault and residual current monitoring in earthed power supply systems (TN/TT systems) where an alarm is to be activated in the event of a fault, but disconnection must be prevented. In addition, the device can be used to monitor single conductors, such as PE conductors, N-PE connections and PE-PAS connections.

Two separately adjustable response ranges  $I_{\Delta n1}$  and  $I_{\Delta n2}$  allow to distinguish between prewarning and alarm ( $I_{\Delta n1} = 50 \dots 100$  % of the set response value  $I_{\Delta n2}$ ).

### **1.3 Information about factory setting**

Page 34 provides a summary of all factory settings.

If you want to reset the residual current monitor to factory settings, refer to page 32.

## 2. Safety information

### 2.1 Safety instructions

In addition to this data sheet, the documentation of the device includes a sheet entitled "Important safety instructions for BENDER products".

### 2.2 Work activities on electrical installations

- All work activities necessary for installation, commissioning or work activities during operation of electrical devices or systems are to be carried out by adequately skilled personnel.
- Observe the relevant regulations applying to work on electrical installations, in particular DIN EN 50110 or its subsequent regulation.



---

*Unprofessional work activities on electrical installations may result in a threat of danger to life and limb!*

---

- If the equipment is used outside the Federal Republic of Germany, the respective national standards and regulations are to be observed. The European standard EN 50110 is recommended to be used as a directive.





## 3. Function

### 3.1 Device features

- AC and pulsed DC sensitive residual current monitor Type A according to IEC 62020
- Adjustable switching hysteresis
- r.m.s. value measurement
- Starting delay, response delay and delay on release
- Measured value display via multi-functional LC display
- Alarm indication via LEDs (AL1, AL2) and changeover contacts (K1, K2)
- N/C operation or N/O operation selectable
- Password protection against unauthorized parameter changing
- Fault memory function can be switched off
- CT connection monitoring

### 3.2 Function

Once the supply voltage  $U_s$  is applied, the starting delay "t" is activated. Measured values exceeded during this time do not influence the switching state of the alarm relays. Residual current monitoring takes place via an external measuring current transformer. The currently measured value is shown on the LC display. In this way any changes can be recognized easily, for example, when circuits are connected to the system. If the measured value exceeds one or both response values, the response delay  $t_{on1/2}$  starts running. After the expiry of the response delay  $t_{on1/2}$ , the selected alarm relay switches and the alarm LEDs light. If the release value is not reached before the expiry of  $t_{on}$ , no alarm will be signalled: the LEDs AL1, AL2 do not light and the alarm relays do not switch. The set release time  $t_{off}$  begins when the measured value again falls below the release value (response value plus hysteresis) after the switching of the alarm relays. After the expiry of  $t_{off}$ , the alarm relays switch back to their initial position. With the fault memory activated, the alarm relays do not change their actual state until the reset button R is pressed. The device func-

tion can be tested using the test button T. The parameterization of the device can be carried out via the LC display and the function keys integrated in the front plate and can be password-protected.

### 3.2.1 Connection monitoring

The CT connections are continuously monitored. In the event of a fault, the alarm relays K1 / K2 switch without delay, the alarm LEDs AL1 / AL2 / ON flash (Error Code E.01). After eliminating the fault, the alarm relays automatically return to their initial position, provided that the fault memory M is deactivated. With the fault memory activated, K1/K2 return to their initial position by pressing the reset button R. A second cascaded measuring current transformer will not be monitored.

### 3.2.2 Additional cascaded measuring current transformer

For applications where residual currents higher than 10 A occur, a second external transformer can be cascaded. The transformer's transmission ratio can be adapted using the correction factor  $n_{RCM}$  in the SEt menu. Refer to page 15 and page 30.

### 3.2.3 Fast response value query

With the display in standard mode, the currently measured response values  $I_{\Delta n1}$  and  $I_{\Delta n2}$  can be queried pressing the Up and Down keys (< 1.5 s). Switch-over to the Menu mode is not required. If you want to exit the fast response value query, press the enter key.

### 3.2.4 Automatic self test

The device automatically carries out a self test after connecting to the system to be monitored and later every 24 hours. During the self test internal functional faults will be detected and appear in form of an error code on the display. The alarm relays are not checked during this test.

### 3.2.5 Manual self test

After pressing the test button for > 1.5 s, the device carries out a self test. During this test, internal functional faults are detected and will be displayed in form of an error code. The alarm relays are not checked during this test.

While the test button T is pressed and held down, all device-related display elements appear on the display.

### 3.2.6 Functional faults

If an internal functional fault occurs, all three LEDs flash. An error code will appear on the display (E01...E32). In such a case please contact the Bender Service.

### 3.2.7 Set the number of reload cycles

If faults occur only temporarily, but recurrently, in the system being monitored, with the fault memory M deactivated, the alarm relays would switch synchronously to the error status.

RL in the out menu can be used to limit the number of these changeover processes. As soon as the preset number of switching cycles is exceeded, the fault memory will come on and an activated alarm remains stored.

### 3.2.8 Assigning alarm categories to alarm relays K1/K2

The alarm categories device error, residual current  $I_{\Delta n1}$ , residual current  $I_{\Delta n2}$  or device test can be assigned to the alarm relay via the "out" menu.

### 3.2.9 Time delays $t$ , $t_{on}$ and $t_{off}$

The times  $t$ ,  $t_{on}$  and  $t_{off}$ , described below, delay the output of alarms via LEDs and relays.

#### 3.2.10 Starting delay $t$

After connection to the supply voltage  $U_S$ , the alarm indication is delayed by the preset time  $t$  (0...10 s).

#### 3.2.11 Response delay $t_{on1/2}$

If the response value is exceeded or not reached, the residual current monitor requires the response time  $t_{an}$ . After the expiry of the response time an alarm is signalled. A set response delay  $t_{on1/2}$  (0...10 s) adds up to the device-related operating time  $t_{ae}$  and delays alarm signalling (total delay time  $t_{an} = t_{ae} + t_{on}$ ). If the residual current fault changes from a value above the response value to a value below the response value, an alarm will not be signalled.

### 3.2.12 Delay on release $t_{off}$

When no alarm exists after deactivating the fault memory, the alarm LEDs go out and the alarm relays switch back to their initial position. After activating the delay on release (0...300 s), the alarm state is continuously maintained for the selected period.

### 3.2.13 Residual current monitoring in window discriminator mode

Change the measuring principle by selecting the window mode (SEt / In). In the window discriminator mode, the threshold values I1 and I2 represent the upper and the lower value. If the measured value is not within this area, an alarm is initiated by the device. See page 30.

### 3.2.14 Password protection (on, OFF)

When the password protection is activated (on), settings are only possible after entering the correct password (0...999).

### 3.2.15 Factory setting FAC

After activating the factory setting, all settings previously changed are reset to delivery status.

### 3.2.16 Erasable history memory

The first alarm value that occurs will be saved in this memory. The memory can be cleared via the menu HiS.

### 3.2.17 External, combined test respectively reset button T/R

Reset = Pressing the external button < 1.5 s

Test = Pressing the external button > 1.5 s

### 3.2.18 Fault memory

The fault memory can be activated, deactivated or set to continuous mode (con). If the fault memory is set to "con" mode, the alarm parameters remain stored even on failure of the supply voltage. Stored alarms can be reset by means of the reset button R.

## 4. Installation and connection



Ensure safe isolation from supply in the installation area. Observe the installation rules for live working.

### Dimension diagram, drawing for screw mounting, push-wire terminal connection

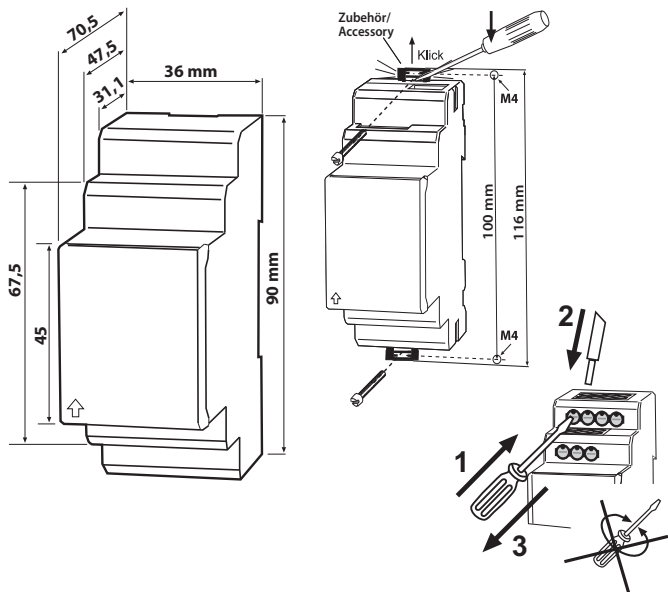

The front plate cover is easy to open at the lower part marked by an arrow.

## 1. DIN rail mounting:

Snap the rear mounting clip of the device into place in such a way that a safe and tight fit is ensured.

Screw fixing:

Use a tool to move the rear mounting clips (a second mounting clip required, see ordering information) to a position that it projects beyond the enclosure. Then fix the device using two M4 screws.

## 2. Wiring

Connect the device according the wiring diagram.

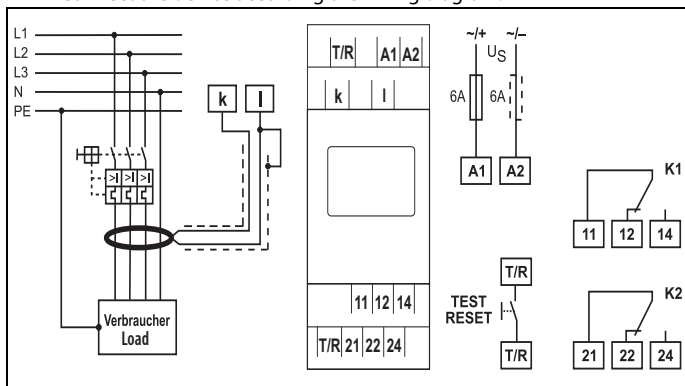

Terminal	Connections
A1, A2	Connection to supply voltage $U_s$
k, I	Connection of measuring current transformers
T / R	Connection to the combined test and reset button
11, 12, 14	Alarm relay K1
21, 22, 24	Alarm relay K2

## Connection of an additional cascaded measuring current transformer

If the residual current range of 10 A is not sufficient, an additional measuring current transformer can be cascaded. Connect the measuring current transformer as illustrated in the drawing below.

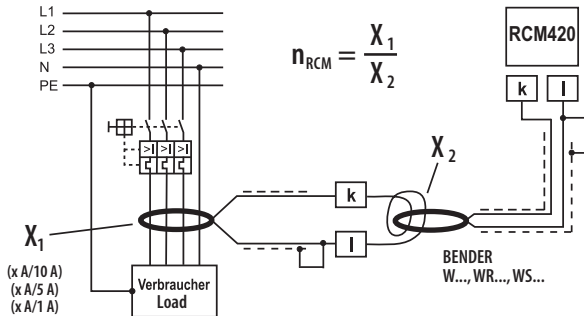

### Example:

An additionally cascaded transformer on the load side has a transmission ratio of  $X_1 = 100$  (500 A / 5 A). That means, when the lowest value of 10 mA is set at the RCM420, a current of 1 A can only just be detected on the primary side of the transformer on the load side. In order to reduce the value that can be detected to 100 mA, 10 turns of the supply cable has to be routed through the transformer on the RCM side.

Hence, the correction factor to be set is

$$n_{RCM} = X_1 : X_2 = 100 : 10 = 10.$$

The correction factor can be set via the S E t / n menu. Refer to page 30.

The correction factor is factory set to 1 and relates to normal operation with one Bender measuring current transformer only ( $X = 600:1$ ).







## 5. Operation and setting

### 5.1 Display elements

A detailed description of the meaning of the display elements is given in the table below.



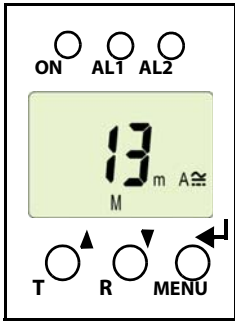

Display elements	Element	Function
	RL	Reload function with memory = off (L = I.)
	n	Transformation ratio factor for a second external measuring current transformer.
	I2	Response value $I_{\Delta n2}$ as mA (Alarm 2)
	I1	Response value $I_{\Delta n1}$ as % of $I_{\Delta n2}$ (Alarm 1, prewarning.)
	r1, 1 r2, 2	Alarm relay K1 Alarm relay K2
	I Hys, %	Response value hysteresis as %.
	ton1, ton2, t, toff	Response delay $t_{on1}$ (K1) Response delay $t_{on2}$ (K2) Starting delay t, Delay on release $t_{off}$ for K2
	M	fault memory active
		Relay operating mode K2
		Password protection enabled

## 5.2 Function of the operating elements

Device front	Element	Function
	<b>ON, green</b>	lights continuously: Power On LED flashes: System fault or connection monitoring fault
	<b>AL1, AL2</b>	LED Alarm 1 lights (yellow): Response value 1 reached ( $I_{\Delta n1}$ ) LED Alarm 2 lights (yellow): Response value 2 reached ( $I_{\Delta n2}$ )
	<b>13 mA M</b>	13 mA flow through the measuring current transformer, fault memory active
	<b>T, ▲</b>	Test button (> 1.5 s): To indicate the available display elements, to start a self test; Up key (< 1.5 s): Menu items/values
	<b>R, ▼</b>	Reset button (> 1.5 s): Deleting the fault memory; Down key (< 1.5 s): Menu items/values
	<b>MENU, ◀</b>	MENU key (> 1.5 s): Starting the menu mode; Enter key (< 1.5 s): Confirm menu item, submenu item and value. Enter key (> 1.5 s): Back to the next higher menu level.

### 5.3 Menu structure

All adjustable parameters are listed in the columns "menu item" and "adjustable parameters". A display-like representation is used to illustrate the parameters in the column menu item. Different alarm categories can be assigned to the alarm relays K1, K2 via the submenus r1, r2. This is done by activation or deactivation of the respective function.

Menu	Sub Menu	Menu item	Activation	Adjustable parameter
<b>AL</b> (response - values)		> I2	- (HI)	$I_{\Delta n2}$ (Alarm 2)
		> I1	- (HI)	$I_{\Delta n1}$ as % of $I_{\Delta n2}$ (Alarm 1, prewarning)
		Hys	-	Hysteresis $I_{\Delta n1} / I_{\Delta n2}$
<b>out</b> (output control)		M	ON	Fault memory
		 1	-	Operating mode K1 (n.c.)
		 2	-	Operating mode K2 (n.c.)
		RL	-	Reload function (memory = off)
	<b>r1</b> (K1: (assignment alarm category))	1 Err	ON	Device error at K1
		r1 I1	off	Prewarning $I_{\Delta n1}$ at K1
		r1 I2	ON	Alarm $I_{\Delta n2}$ at K1
		1 tES	ON	Device test
	<b>r2</b> (K2: (assignment alarm category))	2 Err	ON	Device error at K2
		r2 I1	off	Prewarning $I_{\Delta n1}$ at K2
		r2 I2	ON	Alarm $I_{\Delta n2}$ at K2
		2 tES	ON	Device test

Menu	Sub Menu	Menu item	Activation	Adjustable parameter
t (timing check)	→	t on 1	-	Response delay K1
		t on 2	-	Response delay K2
		t	-	Starting delay
		t off	-	Delay on release K1/K2
Set (device control)	→	l 12	HI	Selectable parameters: High, window function, low
		n	1	Transformation ratio factor for a second external measuring current transformer.
			off	Parameter setting via password
		FAC	-	Re-establish factory settings
		SYS	-	Function blocked
InF	→		-	Display hard / software version
HiS	→	Clr	-	History memory for the first alarm value, erasable

## 5.4 Display in standard mode

By default, the currently measured residual current is displayed. The current response values I1 (prewarning) and I2 (alarm) can be displayed using the Up and Down key. Press the Enter key to return to the measured value.

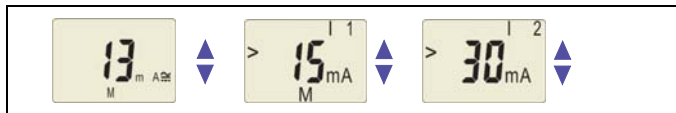

*In the standard mode, the currently set response values I1 and I2 can be displayed using the Up and Down keys.*

## 5.5 Display in menu mode

### 5.5.1 Parameter query and setting: Overview

Menu item	Adjustable parameter
AL	Response values query and setting: <ul style="list-style-type: none"> <li>– Residual current I2 (<math>I_{\Delta n2}</math>) (AL2)</li> <li>– Residual current I1 (<math>I_{\Delta n1}</math>) (AL1)</li> <li>– Hysteresis of the response values: % Hys</li> </ul>
out	Configuration of the fault memory and the alarm relays: <ul style="list-style-type: none"> <li>– Activating/deactivating the fault memory or assign continuous mode (on/off/con)</li> <li>– Select N/O operation (n.o.) or N/C operation (n.c.) individually for each K1/K2</li> <li>– Specify the number of the reload cycles</li> <li>– Assign the alarm category I1 (<math>I_{\Delta n1}</math>) or I2 (<math>I_{\Delta n2}</math>), relay test or device error individually to K1/K2 (1, r1/ 2, r2).</li> </ul>
t	Set delays: <ul style="list-style-type: none"> <li>– Response delay <math>t_{on1}/t_{on2}</math></li> <li>– Starting delay t</li> <li>– Delay on release <math>t_{off}</math> (LED, relay)</li> </ul>
SEt	Device control parameter setting: <ul style="list-style-type: none"> <li>– Select the appropriate parameter for response values: overcurrent mode (HI), undercurrent mode (Lo) or window mode (In).</li> <li>– Set the correction factor <math>n_{RCM}</math> (n) for additional cascaded current transformer.</li> <li>– Enable or disable password protection, change the password.</li> <li>– Re-establish factory settings.</li> <li>– Service menu SyS blocked</li> </ul>
InF	Query hard and software version
HiS	Query the first stored alarm value.
ESC	Move to the next higher menu level (back)

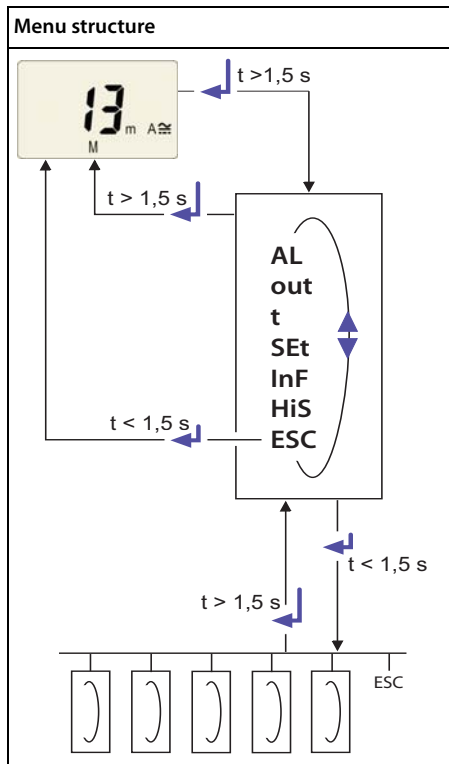

### Parameter settings

The following description is based on the fact that the device is in the stand-

ard mode and that the measured value of the residual current is being indicated, refer to page 21.

An example is given here on how to change the alarm response value I1 ( $I_{\Delta n1}$ ). It is presumed that the option overcurrent (HI) has been selected in the SEt/I 12 menu (factory setting). Proceed as follows:

1. To access the menu mode, press the MENU/Enter key for more than 1.5 seconds. The flashing short symbol AL appears on the display.
2. Confirm with Enter. The parameter response value > I 2 flashes, in addition the associated overcurrent value > 30 mA appears.
3. Use the Down key to select the parameter response value I 1. The parameter I 1 flashes, in addition the associated percentage value for prewarning 50 % of I 2 appears.
4. Confirm with Enter. The current value for prewarning appears on the flashing display.
5. Use the Up or Down key to set the appropriate response value. Confirm with Enter. I 1 flashes.
6. You can exit the menu by:
  - Pressing the Enter key for more than 1.5 seconds to reach the next higher level or
  - Selecting the menu item ESC and confirming with Enter to reach the next higher level.



---

*The currently active segments are flashing! In the figures below, the segments where device settings can be carried out are highlighted by an oval. The menu mode can be reached by pressing the MENU key for more than 1.5 seconds.*

---

### 5.5.2 Changeover from overcurrent to undercurrent mode or to window mode

The operating mode can be changed in the SEt/I 12 menu using the parameters HI, Lo and In. By default, overcurrent operation (HI) is set. Refer to page 30 for a detailed description on how to change over to the window mode.



### 5.5.3 Response value setting for overcurrent:

- Response value I2 (overcurrent  $I_{\Delta n2}$ )
- Response value I1 (overcurrent  $I_{\Delta n1}$ )
- Hysteresis (Hys) of the response values  $I_{\Delta n1}$ ,  $I_{\Delta n2}$

#### Increasing the response value I2 (alarm overcurrent)

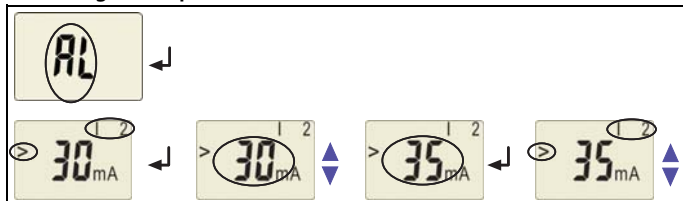

#### Increasing the response value I1 (prewarning overcurrent).

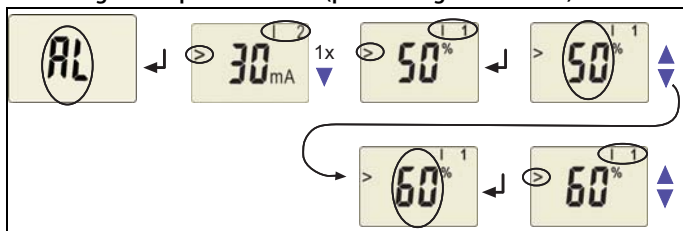

#### Setting the hysteresis of the response value

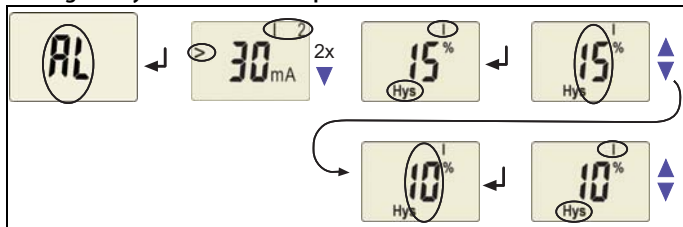

## 5.5.4 Setting the fault memory and alarm relay operating mode

### Setting the fault memory to con mode

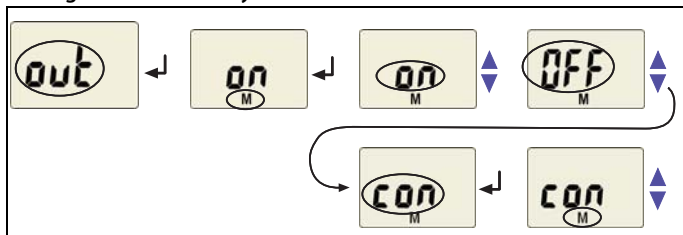

### Setting the alarm relay K1 to N/O operation (n.o.)

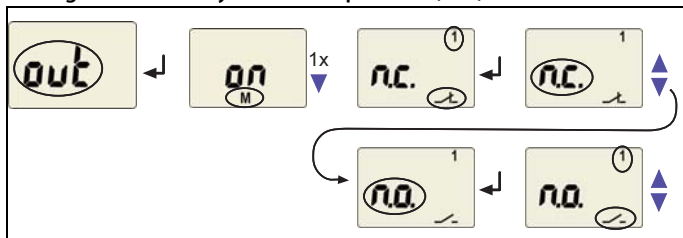

### Setting the number of reload cycles

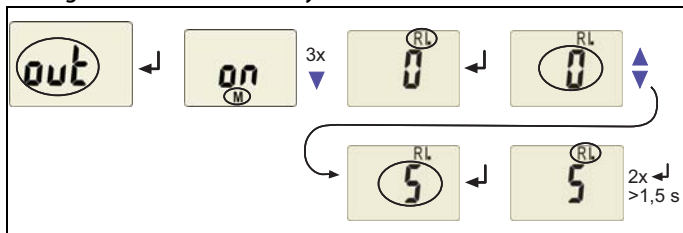

### 5.5.5 Assigning alarm categories to the alarm relays

Overcurrent, undercurrent and device-related errors of the residual current monitor can be assigned to the alarm relays K1 (r1, 1) and K2 (r2, 2). By default, the alarm relays K1 and K2 signal prewarning and alarm in case of overcurrent and device-related errors.

#### Alarm relay K1: Deactivating the category device error

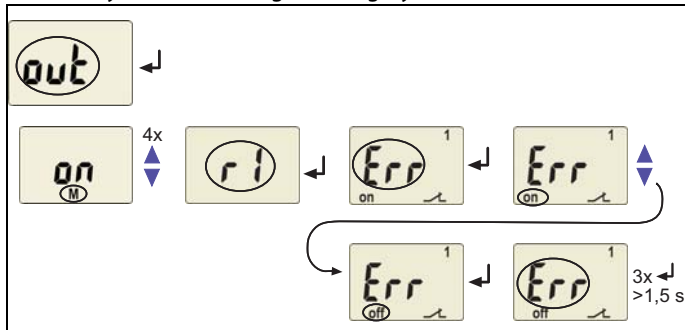

#### Alarm relay K1: Deactivating the category response value I1

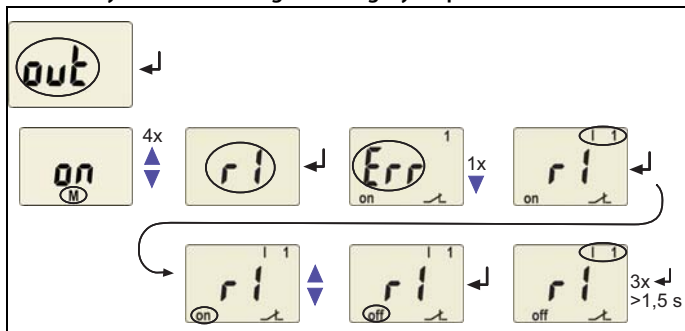

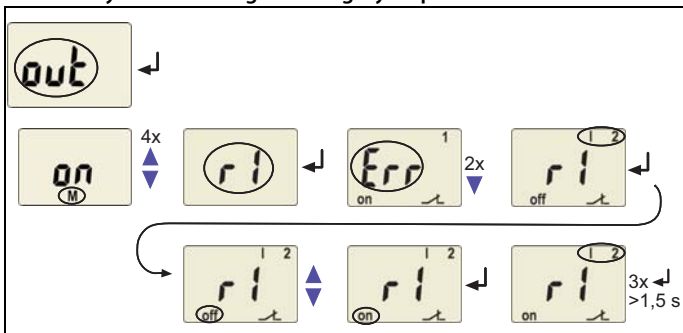
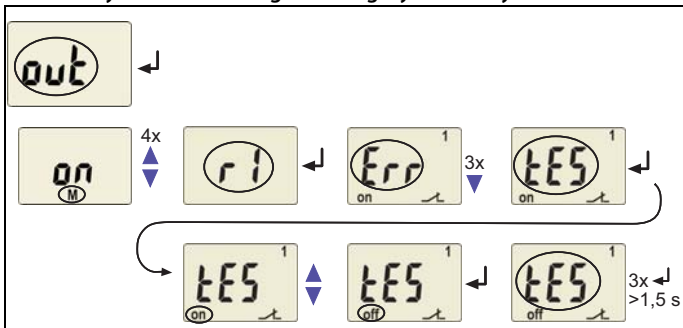
**Alarm relay K1: Activating the category response value I2**

**Alarm relay K1: Deactivating the category "Alarm by device test"**

When an alarm relay (K1/K2) has been deactivated in the menu, an alarm will not be signalled by the respective changeover contact! An alarm will only be indicated by the respective alarm LED (AL1/AL2)!

### 5.5.6 Set the time delays

The following delays can be set:

- Response delay  $t_{on1}$  (0...10 s) for K1, and  $t_{on2}$  (0...10 s) for K2
- Starting delay  $t$  (0...10 s) when the device is being started
- Common delay on release  $t_{off}$  (0...99 s) for K1, K2. The setting  $t_{off}$  is only relevant when the fault memory M is deactivated.

The operating steps for the setting of the response delay  $t_{on1}$  and the starting delay  $t$  are illustrated by way of example.

#### Setting the response delay $t_{on1}$

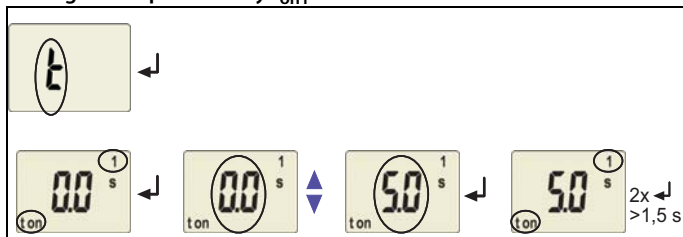

#### Setting the starting delay $t$

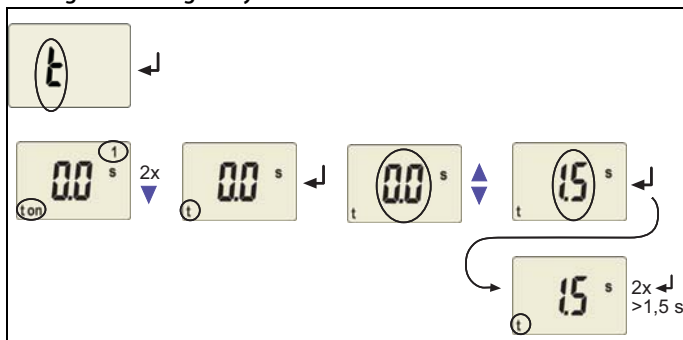

### 5.5.7 Changing from overcurrent operation to window operation

Use this menu item to set whether the response values of the device apply to overcurrent (HI) or undercurrent operation (Lo). In addition, window operation (In) can be selected.

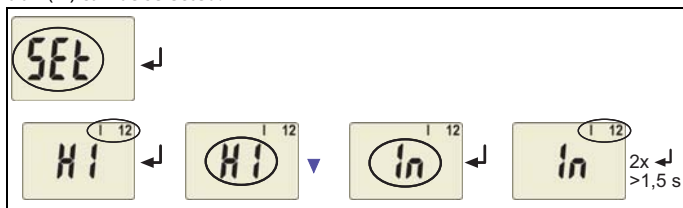

### 5.5.8 Setting the correction factor for an additional cascaded current transformer

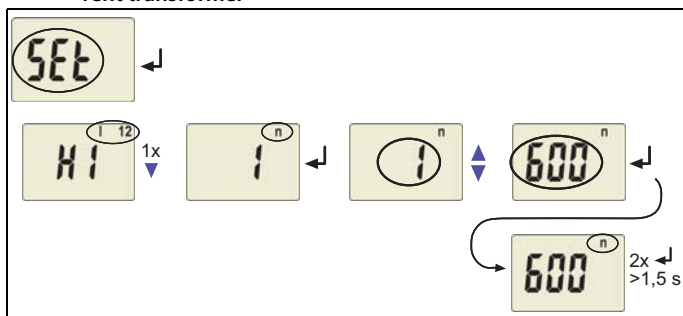

Factory setting without cascaded transformer:  $n = 1$ .

### 5.5.9 Factory setting and password protection

Use this menu to activate the password protection, to change the password or to deactivate the password protection. In addition, you can reset the device to its factory settings.

#### a) Activating the password protection

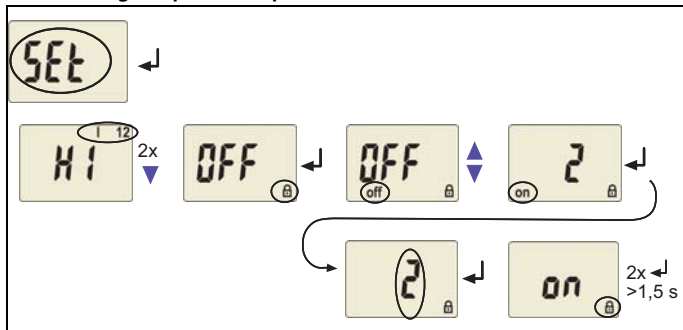

#### b) Changing the password

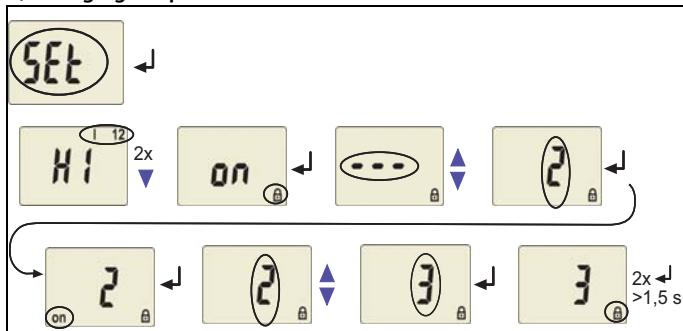

### c) Deactivating the password protection

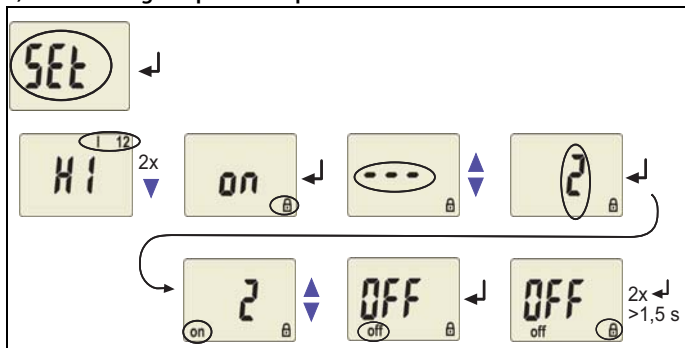

### 5.5.10 Re-establishing the factory settings

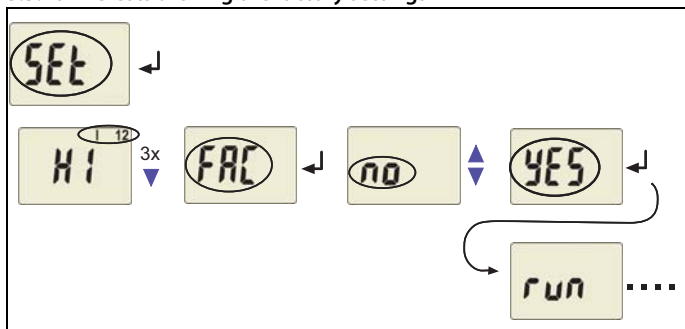



### 5.5.11 Device information query

This function is used to query the software (1.xx) versions. After activating this function, data will be displayed as a scrolling text. Once one pass is completed you can select individual data sections using the Up/Down keys.

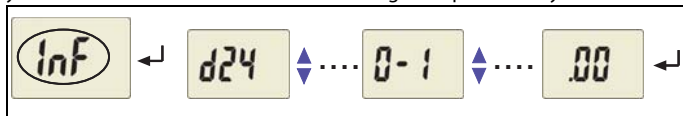

### 5.5.12 History memory query

The history memory can be selected via the menu HiS. Use the Up and Down keys to view the next display. If Clr is flashing, the history memory can be cleared by pressing the Enter key.

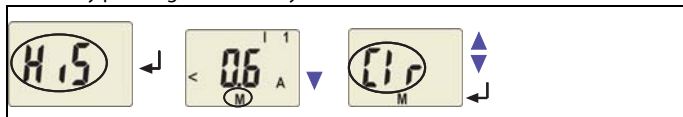

## 5.6 Commissioning

Prior to commissioning, check proper connection of the residual current monitor.

## 5.7 Factory setting



<i>Response value overcurrent I1 (prewarning)</i>	15 mA (50 % of I2)
<i>Response value overcurrent I2 (alarm)</i>	30 mA
<i>Hysteresis:</i>	15 %
<i>Fault memory M:</i>	activated (on)
<i>Operating mode K1/K2</i>	N/C operation (n.c.)
<i>Starting delay:</i>	$t = 0.5 \text{ s}$
<i>Response delay:</i>	$t_{on1} = 1 \text{ s}$
	$t_{on2} = 0 \text{ s}$
<i>Delay on release:</i>	$t_{off} = 1 \text{ s}$
<i>Transformer correction factor <math>n</math> (<math>n_{RCM}</math>)</i>	1
<i>Password:</i>	0, deactivated (Off)

## 5.8 Standards, approvals and certifications



## 6. Technical data

### 6.1 Data in tabular form

( )\* = factory setting

#### Insulation coordination acc. to IEC 60664-1/IEC 60664-3

Rated insulation voltage .....	250 V
Rated impulse voltage/pollution degree .....	4 kV / III
Protective separation (reinforced insulation) between: .....	(A1, A2) - (k/I, T/R) - (11, 12, 14) - (21, 22, 24)
Voltage test according to IEC 61010-1 .....	2.21 kV

#### Supply voltage

RCM420-D-1:

Supply voltage $U_s$ .....	AC 16...72 V / DC 9.6...94 V
Frequency range $U_s$ .....	42...460 Hz

RCM420-D-2:

Supply voltage $U_s$ .....	AC/DC 70...300 V
Frequency range $U_s$ .....	42...460 Hz
Power consumption .....	$\leq 3$ VA

#### Measuring circuit

External measuring current transformer type .....	W..., WR..., WS...
Load .....	68 $\Omega$
Rated insulation voltage (measuring current transformer) .....	800 V
Operating characteristic acc. to IEC 62020 .....	type A
Frequency range .....	42...2000 Hz
Measuring range .....	3 mA...16 A
Relative uncertainty .....	0 ... -20 %
Operating uncertainty .....	0...-30 %

#### Response values

Rated residual operating current $I_{\Delta n1}$ (prewarning, AL1) .....	50...100 % $\times I_{\Delta n2}$ , (50%)*
Rated residual operating current $I_{\Delta n2}$ (Alarm, AL2) .....	10 mA...10 A (30 mA)*

Hysteresis ..... 10...25 % (15%)\*

### Specified time

Starting delay  $t$  ..... 0...10 s (0.5 s)\*

Response delay  $t_{on2}$  (Alarm) ..... 0...10 s (0 s)\*

Response delay  $t_{on1}$  (prewarning) ..... 0...10 s (1 s)\*

Delay on release  $t_{off}$  ..... 0...300 s (1 s)\*

Operating time  $t_{ae}$  at  $I_{\Delta n} = 1 \times I_{\Delta n1/2}$  .....  $\leq 180$  ms

Operating time  $t_{ae}$  at  $I_{\Delta n} = 5 \times I_{\Delta n1/2}$  .....  $\leq 30$  ms

Response time  $t_{an}$  .....  $t_{an} = t_{ae} + t_{on1/2}$

Recovery time  $t_b$  .....  $\leq 300$  ms

Number of reload cycles ..... 0...100 (0)\*

### Cable lengths for measuring current transformers

Single wire  $\geq 0.75 \text{ mm}^2$  ..... 0...1 m

Single wire, twisted  $\geq 0.75 \text{ mm}^2$  ..... 0...10 m

Shielded cable  $\geq 0.75 \text{ mm}^2$  ..... 0...40 m

Recommended cable

(shielded, shield on one side connected to terminal I of the RCM420, not connected to earth) .....

J-Y(St)Y min. 2 x 0.8

Connection ..... screw terminals

### Displays, memory

Display range, measured value ..... 3 mA...16 A

Error of indication .....  $\pm 15\%$  /  $\pm 2$  digit

Measured-value memory for alarm value ..... data record measured values

Password ..... off / 0...999 (OFF)\*

Fault memory alarm relay ..... on / off (off)\*

### Inputs/outputs

Cable length for external test / reset button ..... 0...10 m

### Switching elements

Number of switching elements ..... 2 x 1 changeover contact

Operating principle ..... N/C operation/ N/O operation (N/O operation)\*

Electrical service life under rated operating conditions ..... 10000 switching operations

Contact data acc. to IEC 60947-5-1:

Utilization category.....	AC-13.....	AC-14.....	DC-12.....	DC-12.....	DC-12
Rated operational voltage .....	230V .....	230V .....	24V .....	110V .....	220 V
Rated operational current.....	5 A.....	3 A.....	1 A.....	0.2 A.....	0.1 A
Minimum contact load.....					1 mA at AC / DC ≥ 10 V

## Environment/EMC

EMC .....	IEC 62020
Operating temperature .....	-25 °C...+55 °C
Classification of climatic conditions IEC 60721	
Stationary use (IEC 60721-3-3) .....	3K5 (except condensation and formation of ice)
Transportation (IEC 60721-3-2) .....	2K3 (except condensation and formation of ice)
Storage (IEC 60721-3-1) .....	1K4 (except condensation and formation of ice)
Classification of mechanical conditions acc. to IEC 60721:	
Stationary use (IEC 60721-3-3) .....	3M4
Transportation (IEC 60721-3-2) .....	2M2
Storage (IEC 60721-3-1) .....	1M3

## Connection

Connection type.....	<b>screw-type terminals</b>
Connection properties:	
rigid/ flexible/ conductor sizes .....	0.2..4 / 0.2..2.5 mm <sup>2</sup> / AWG 24...12
Multi-conductor connection (2 conductors with the same cross section):	
rigid, flexible .....	0.2..1.5 / 0.2..1.5 mm <sup>2</sup>
Stripping length .....	8...9 mm
Tightening torque .....	0.5..0.6 Nm
Connection type.....	<b>push-wire terminals</b>
Connection properties:	
Rigid .....	0.2..2.5 mm <sup>2</sup> ( AWG 24...14)
Flexible without ferrules.....	0.2..2.5 mm <sup>2</sup> ( AWG 24...14)
Flexible with ferrules .....	0.2...1.5 mm <sup>2</sup> ( AWG 24...16)
Stripping length .....	10 mm
Opening force.....	50 N
Test opening, diameter.....	2.1 mm

## Other

Operating mode .....	continuous operation
----------------------	----------------------

Position of normal use .....	any
Protection class, internal components (DIN EN 60529) .....	IP30
Degree of protection, terminals (DIN EN 60529) .....	IP20
Enclosure material .....	polycarbonate
Flammability class .....	UL94V-0
DIN rail mounting acc. to .....	IEC 60715
Screw mounting.....	2 x M4 with mounting clip
Weight .....	≤ 150 g

( ) \* = factory setting

## 6.2 Ordering information

	RCM420-D...-1	RCM420-D...-2
<b>Response range <math>I_{\Delta n}</math></b>	10 mA...10 A	10 mA...10 A
<b>Rated frequency</b>	42...2000 Hz	42...2000 Hz
<b>Measuring current transformers</b>	W..., WR..., WS... series	W..., WR..., WS... series
<b>Supply voltage <math>U_s^*</math></b>	DC 9.6 V...94 V / AC 42...460 Hz, 16...72 V	DC 70...300 V / AC 42...460 Hz, 70...300 V
<b>Art. No.:</b> (B 7... = push-wire terminal)	B 7401 4001 B 9401 4001	B 7401 4002 B 9401 4002
<b>*Absolute values of the voltage range</b>		

## External measuring current transformers

Type	Inside diameter (mm)	Art. No.
W20	20	B 9808 0003
W35	35	B 9808 0010
W60	60	B 9808 0018
W120	120	B 9808 0028
W210	210	B 9808 0034
WR70x175	70 x 175	B 9808 0609
WR115x305	115 x 305	B 9808 0610
WS50x80	50 x 80	B 9808 0603
WS80x120	80 x 120	B 9808 0606

### RCM420 accessories

Mounting clip for screw fixing (1 piece per device) ..... B 9806 0008

### Measuring current transformers accessories

Snap-on mounting for DIN rail: W20... /W35... ..... B 9808 0501

Snap-on mounting for DIN rail: W60 ..... B 9808 0502

## 6.3 Error codes

Should, contrary to all expectations, a device error occur, error codes will appear on the display. Typical error codes are described below:

Error code	Meaning:
E.01	Fault CT connection monitoring Appropriate action: Check CT connection for short-circuit or interruption. After eliminating the fault, the error code will be automatically deleted.
E.02	Fault CT connection monitoring during manual self test. Appropriate action: Check CT connection for short-circuit or interruption. After eliminating the fault, the error code will be automatically deleted.
E....	Appropriate action when error codes > 02 occur: Carry out a reset. Reset the device to factory setting. After eliminating the fault, the error code will be automatically deleted. If the fault continues to exist, please contact the Bender Service.



# INDEX

## A

- Adjustable parameters, list 19
- Automatic self test 10

## C

- Connection of an additional cascaded measuring current transformer 15
- Continuous mode (con), fault memory 12

## D

- Delay on release toff 12
- Deleting the fault alarms 18
- Device features 9
- Display elements 17
- Display in standard mode 21

## E

- ENTER key 18
- Error codes 40
- Example of parameter setting 24

## F

- Factory setting 12, 34
- Function 9
- Functional faults 11

## I

- Installation and connection 13

## K

- K1/K2: assignment alarm category 19

## L

- LED Alarm 1 lights 18
- LED Alarm 2 lights 18

## M

- Manual self test 10
- Manual, target group 5
- Menu
  - AL (response values) 19
  - HiS (history memory for the first alarm value) 20
  - InF (hard and software version) 20
  - out (output control) 19
  - Set (device control) 20
  - t (timing check) 20
- Menu structure, overview 19

## N

- Notes for the user 5

## O

- Operating elements, function 18
- Operation and setting 17
- Ordering information 38

**P**

Parameter query and setting, overview 22

Parameter setting

- Activating or deactivating the password protection 31
- Assigning alarm categories to the alarm relays 27
- Changing from overcurrent operation to window operation 30
- Set response values 25
- Set the time delays 29
- Setting the fault memory to con mode 26

Password protection 12

**R**

Reset button 18

Residual current monitoring in window discriminator mode 12

Response delay ton 11

**S**

Second external measuring current transformer 10

Select the appropriate parameter for response values 22

Set response values

- Hysteresis 25
- Overcurrent ( $> I$ ) 25

Set the correction factor for additional cascaded current transformer. 30

Setting the number of reload cycles 26

Starting delay t 11

Starting the menu mode 18

**T**

Technical data 35

Test button 18

**W**

Wiring diagram 14

Wondow mode 30

Work activities on electrical installations 7





D611003301



**Bender GmbH & Co. KG**

Londorfer Str. 65 • 35305 Grünberg • Germany

Postfach 1161 • 35301 Grünberg • Germany

Tel.: +49 6401 807-0

Fax: +49 6401 807-259

E-Mail: [info@bender-de.com](mailto:info@bender-de.com)

Web: <http://www.bender-de.com>

**BENDER Group**

---